



M•ONE

DUAL EFFECTS PROCESSOR



USER'S MANUAL

TABLE OF CONTENTS

INTRODUCTION

<i>Table of contents</i>	3
<i>Introduction</i>	5
<i>Front Panel</i>	6
<i>Rear Panel</i>	8
<i>Soldering Instructions</i>	8
<i>Signal flow diagram</i>	9

BASIC OPERATION

<i>The M•ONE Display</i>	10
<i>I/O Setup</i>	11
<i>Clock Mismatch</i>	11
<i>Utility & MIDI</i>	12
<i>Routings</i>	13
<i>Recall</i>	16
<i>Store</i>	17
<i>Tap</i>	17

ALGORITHMS

Reverb	
<i>Hall</i>	18
<i>Room</i>	19
<i>Plate 1</i>	20
<i>Plate 2</i>	21
<i>Spring</i>	22
<i>Live</i>	23
<i>Ambience</i>	24
Other Algorithms	
<i>Delay - One Tap & two Tap</i>	25
<i>Chorus - Classic & 4-Voice</i>	26
<i>Flange - Classic & 4-Voice</i>	27
<i>Pitch - Detune & Pitch Shift</i>	28
<i>Parametric Equalizer</i>	29
<i>Compressor & Limiter</i>	30
<i>Gate/Expander</i>	31
<i>De-esser</i>	32
<i>Tremolo - Hard & Soft</i>	33
<i>Phaser - Vintage & Smooth</i>	34

APPENDIX

<i>Important Safety Instructions</i>	35
<i>Certificate of Conformity</i>	36
<i>MIDI Implementation Chart</i>	37
<i>Technical Specifications</i>	38
<i>Troubleshooting</i>	39
<i>Preset List</i>	40

INTRODUCTION

Congratulations on the purchase of your new TC Electronic M•ONE unit.

The M•ONE is a Dual Engine Multi-effects Processor, focusing mainly on high quality Reverbs. The M•ONE can be used for a number of purposes due to flexible routing of the two Engines and more than 20 TC algorithms. Do you want two independent Reverbs, controlled from separate Auxiliary sends? Select the Dual Input Routing plus two Reverbs, and you are up and running. Do you want a compressor in front of a delay? Select the Serial Routing, a Compressor and a Delay. You can even tap the Delay time on the TAP key. Or maybe you just want stick with that one Routing, no matter the preset? Simply use the Routing Lock function to avoid routing changes at preset change. It is really as easy as that, go ahead and tweak some keys and knobs. We hope you have as much pleasure using the M•ONE as we had making it.

Though the M•ONE is focusing on high quality Reverb you will discover that the M•ONE also covers a wide variety of other algorithms. Experience and enjoy !

- Hall
- Room
- Plates 1&2
- Spring
- Live
- Ambience
- Delay One Tap
- Delay Two Tap
- Chorus Classic & 4-voice
- Flange: Classic & 4-voice
- Pitch: Detune & Pitch Shift
- Parametric EQ
- Compressor/Limiter
- Gate/Expander
- De-esser
- Tremolo
- Phaser

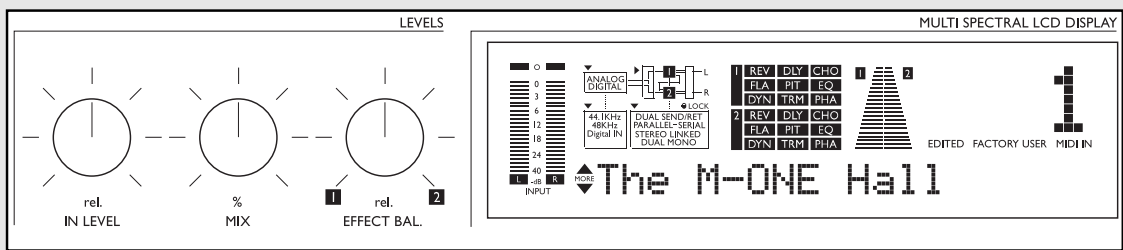

FRONT PANEL

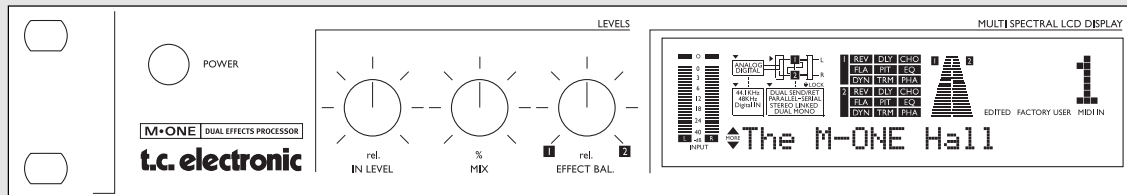

POWER button

Power on/off.

IN LEVEL knob

Adjusts the Input level.

At center position a relay will switch the Input circuit between consumer and pro level. This will insure optimal Input gain range and superb "signal to noise" ratio is achieved.

MIX knob

Adjusts the global mix between dry and wet signal.
Fully clockwise is 100% effect.

EFFECT BAL knob

Adjusts the balance between the two Engines.

INPUT Meters

The Peak meter shows the Input level of left/right channels.

The meter range is:

0, -3, -6, -12, -18, -24, -40.

OVERLOAD LEDs

The OVERLOAD LEDs indicate one of two situations:

- The Input level is too hot and therefore overloading.
- There is an internal DSP overflow.

The Overload LED is lit when 1 sample is @ -1dBFS.

ANALOG/DIGITAL LED

ANALOG/DIGITAL indicator states the selected Input. Input type is selected in the "I/O Setup" menu.

SAMPLE RATE indicator

The SAMPLE RATE indicator shows the clock source and the incoming master clock. The "Digital In" icon will be blinking if no clock or unacceptable clock is found.

ROUTING indicator

Indication of what Routing mode the M•ONE currently is using.

ALGO Indicator

Shows the currently used algorithms in each of the two Engines.

DYNAMIC meters 1+2

These two meters show the gain reduction when an Engine is running Dynamic algorithms.

The Dynamic algorithms are: Compressor, Limiter, Gate, Expander and De-esser.

DISPLAY

Displays the preset number and the preset type: Factory or User.

EDITED icon

This icon will be lit as soon as the current recalled preset has been modified.

FACTORY/USER icon

Shows whether you are operating in the Factory or the User bank.

MIDI IN icon

Shows any incoming MIDI activity.

FRONT PANEL

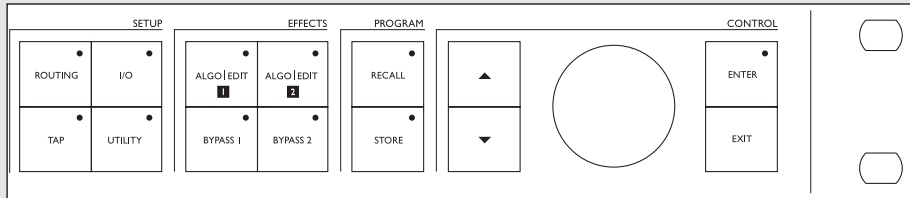

ROUTING key

Press the ROUTING key to set the Engine Routing.
The options are: Dual Send /Ret, Parallel, Parallel/Serial, Serial, Stereo, Dual Mono.

I/O SETUP

Basic parameters are set here.

- Input source - Analog/Digital.
- Sample Rate - 44.1/48kHz/DI
- Bypass Mode - See Bypass keys 1 and 2.
- Global Output level.
- Dither 16, 20 or 24(off).

TAP key

Tap this key to enter the global Tap tempo and to enter the Tap menu. Subdivision of the tapped tempo is setup in this menu. The tapped tempo can be used for Delay time, Chorus rate etc.

UTILITY

MIDI, Sys-Ex ID, Routing-lock, Bypass mode, Pedal function and Display View angle.

ALGO/EDIT 1+2

Press this key to enter the Edit display and the Algorithm Change display of the currently selected Engine.

BYPASS keys 1 and 2

The Bypass mode is set up in Utility. There are three different Bypass modes:

- 1 0% Mix:
The Input signal is passed directly to the Output.
- 2 FX Input:
Cuts only the Engine Input in order to let the effect "ring out", but will still leave the same amount of dry signal coming through.
- 3 FX Output:
Cuts only the Engine Output in order to kill the FX instantaneously, but leaves the same amount of dry signal coming through.

RECALL key

Selects the Recall menu.
Select a desired preset using the CONTROL wheel and press the ENTER key to enter/load the selected preset.

STORE key

Selects the Store menu. Presets can be stored in the User bank only. Location is selected using the CONTROL wheel. Operation is confirmed using ENTER.

CURSOR UP/DOWN

Use the cursors to move around in the display.

ENTER key

Confirms operations. The ENTER key LED will indicate when this key can be used.

EXIT key

Is used to exit a menu or to disapprove an action.

CONTROL wheel

Is used to change values.

REAR PANEL

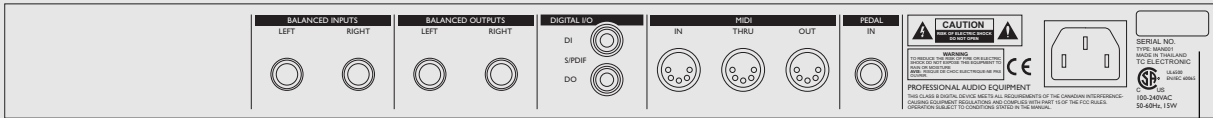

Balanced Jack Analog Inputs

Balanced Jack Analog Outputs

Digital S/PDIF Input/Output

MIDI In, Out, Thru

Pedal Input

Power Input

Serial no.

(Use Left Input for Mono)

MIDI Cable

DIN CONNECTOR
5POLE - MALE
45 degrees

DIN CONNECTOR
5POLE - MALE
45 degrees

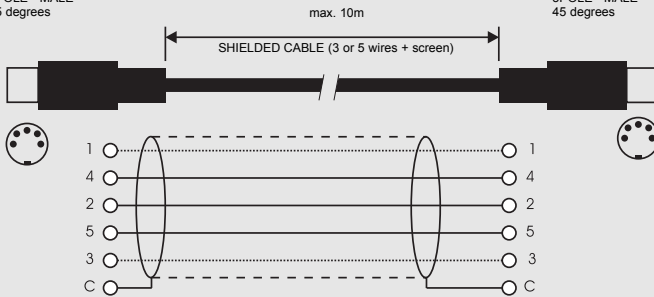

Jack (unbalanced) - XLR

Sleeve - Pin 1 (Ground)
Tip - Pin 2 (Hot)
Sleeve - Pin 3 (Cold)

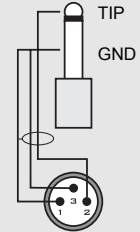

Jack (balanced) - XLR

Sleeve - Pin 1 (Ground)
Tip - Pin 2 (Hot)
Ring - Pin 3 (Cold)

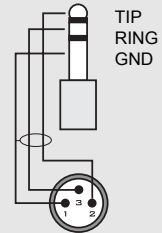

Pedal Cable

JACK PLUG
Mono - male
Ø 6.35mm, 1/4"

PEDAL SWITCH
or similar

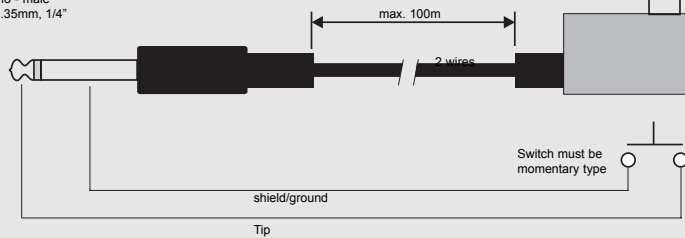

SIGNAL FLOW

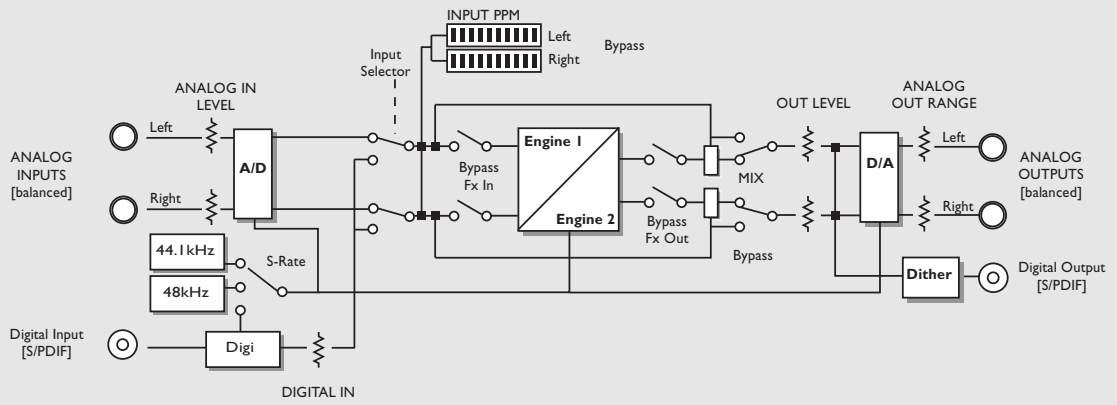

THE M•ONE DISPLAY

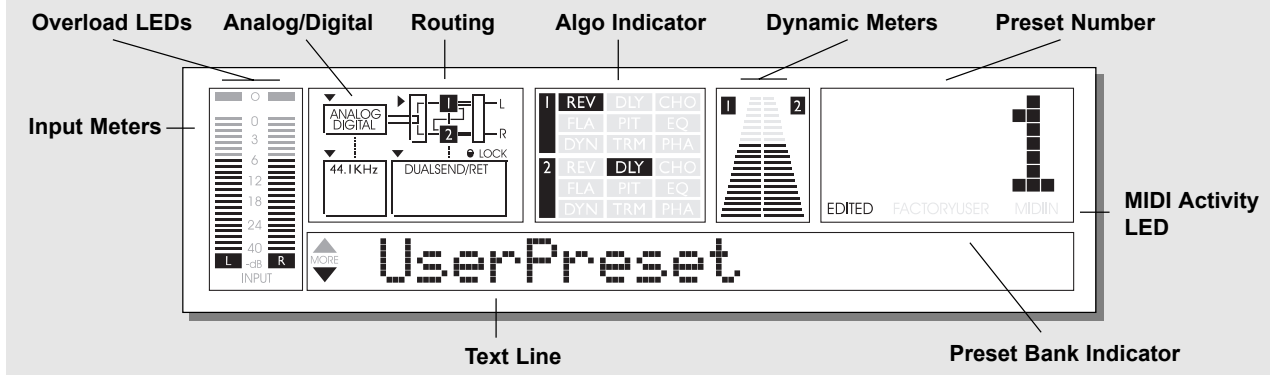

Analog/Digital

Analog/Digital indicator states the chosen Input. This choice is done in the "I/O Setup" menu. The Input choice is global
Icons: Analog, Digital

Sample Rate

The Sample Rate indicator shows the clock source and the incoming master clock. These can be: Digi In, 44.1kHz, 48kHz.

Example

- When locked to an external digital signal, the indicator will display: Digi In and 44.1.
- While using analog Inputs and the internal clock will display: 44.1.

In case of no clock or unacceptable clock, the Digital In icon will be blinking indicating the error situation. The Sample Rate choice is global.

Routing Fig and text

Shows the current Routing. Options are: Dual Send/Return, Parallel/Serial, True Stereo and Dual Mono.

Algo Indicator

Shows the running algorithm in each of the two Engines. Push any of the EDIT keys to scroll through the available effect algorithms. Select between:
Rev, Dly, Cho, Fla, Pit, EQ, Dyn, Trm and Pha.

Dynamic Meters

These two meters are used to show the gain reduction when one of the Engines is running a dynamic algorithm. Dynamic algorithms are: Compressor, Limiter, Gate, De-esser and Expander.

Preset Number

The current preset number.

Edited

This icon will be lit as soon as the current preset has been modified.

Factory/User

Shows whether you are operating in the Factory or User bank.

MIDI In

Indicates the presence of incoming MIDI data.

Text Line

This 20 character text line is used to display preset names as well as selected functions.

I/O SETUP

I/O Setup

Basic operation

- Press the I/O SETUP key to enter the global setup parameters of the M•ONE.
 - Use the ARROW keys to select parameters and the CONTROL wheel to change parameter values.
- All changes in the I/O Setup menu are instantly effective.

Input Source

Select Analog Input

Select the Source parameter using the ARROW keys. The source display arrow is lit. Dial the CONTROL wheel to select between Analog or Digital. When "Analog" is selected M•ONE automatically defaults to the internal 44.1kHz clock as Sample Rate and analog Input is lit in the display.

Select Digital Input

When "Digital" is selected the M•ONE attempts to lock to the S/PDIF Input. The incoming clock will be displayed by the 44.1 or 48kHz display icons and the Digital In icon will be lit. During the lock-up period the Digital In icon will be blinking indicating none or unacceptable clock, and the Outputs are muted. When "lock" is achieved the matching Clock Rate icon is lit, and the Outputs are un-muted.

Clock

Analog Input

When Input source is analog the following Sample Rates are available:
Internal 44.1kHz - The M•ONE runs at internal 44.1kHz.
Internal 48kHz - The M•ONE runs at internal 48kHz.
Digital - The M•ONE locks to the incoming Digital clock.

Digital Input

When Input Source is digital the M•ONE following Sample Rates are available:
Internal 44.1kHz - The M•ONE runs at internal 44.1kHz.
Internal 48kHz - The M•ONE runs at internal 48kHz.
Digital - The M•ONE locks to the incoming Digital clock.



Please note that when using internal clock with external digital audio, the incoming digital audio must be in sync with the M•ONE internal clock in order to avoid slip-samples.



Rate Mismatch

This Error message will occur in the display if the M•ONE detects slipsamples. Typically this problem only occurs in very special clock setups e.g. if the M•ONE is running via internal clock, while processing audio from the Digital Input. If the incoming clock and the internal clock do not match the M•ONE will display the above written error message.

Out Range

Sets the maximum Gain range of the analog Output stage.
Range: 2dBu, 8dBu, 14dBu and 20dBu.

Out level

Controlling the overall digital/analog Output level.
0 to Off (-100dB) in 1dB increments.

Digital In Gain

Sets the digital Input level. This level only affects the digital level.

Dither

Going from one type of bit resolution to a lower, e.g. from 24 bit to 16 bit, you actually lose 8 bits of information. The process of cutting off bits is called truncation and it introduces digital distortion of low level signals, due to the lack of complete signal information. To compensate for this, dither must be applied. Dither is a small amount of filtered noise that generates randomization at the noise floor, ensuring a less distorted low level signal. Dithering is relevant only on digital Outputs and it is always the receiving device that determines the number of bits you must dither to. A CDR or a DAT recorder should normally be dithered to 16 bit.

UTILITY & MIDI

Utility

Basic operation

- Press the UTILITY key to enter the local setup parameters of the M•ONE.
 - Use the ARROW keys to select parameters and the CONTROL wheel to change parameter values.
- All changes are instantly effective in the Utility menu.

MIDI Channel

Sets the responding MIDI channel of the M•ONE.
Range: Off/1-16/Omni.

MIDI CC

Determines whether the M•ONE should respond to MIDI Continuous Controllers or not.
Range: On/Off.

MIDI Bulk Dump

Press ENTER to perform a Bulk Dump of all presets to an external MIDI device. The M•ONE is always ready to receive MIDI Bulk Dump information.

MIDI Sys-Ex ID

Determines the Sys-Ex ID number of the unit.
All effects parameters; also changes and routings can be changed through MIDI Sys-Ex via an external MIDI device. In order to define which unit the sent MIDI Sys-Ex information should reach, the appropriate ID number must be set.

Program Bank

Determines which bank an external MIDI device will address in the M•ONE when sending a program change. The options are: Factory, User or External. When External is selected controller #32 can be used to address either the Factory or the User bank.

Factory bank: Controller #32=0
User bank: Controller #32=1

Routing Lock

Locks the current Routing, meaning that the current selected routing will act as a "global routing" and that "pre-set routings" will not take effect when presets are recalled.

Tap Unit

Selects whether the Tapped tempo in the Tap menu should be displayed in ms (milliseconds) or BPM (Beats Per Minute).

Bypass Mode

There are three different Bypass modes:

0% Mix

The Input signal is passed directly to the Output.

FX Input

Shuts off the Engine Input in order to let the effect "ring out", but leaves the same amount of dry signal through the unit.

FX Output

Shuts off the Engine Output in order to kill the FX instantaneously, but leave the same amount of dry signal coming through.

Pedal setup

Sets the function of the back panel Pedal jack. The Pedal Input uses momentary switches only.
Range: Bypass 1, Bypass 2, Bypass 1&2, Tap.

Viewing Angle

Adjusts the LCD display backlight for better viewing comfort.

ROUTINGS

The Routing Menu sets the Routing of the two Engines. When the Routing menu is entered, the arrow in the Routing display icon is lit. Routings are stored with presets, but it is also possible to keep a locked “global routing” meaning that preset routings do not take effect. This is set in the Utility menu.

Basic operation

- Press the ROUTING key to enter the Routing display.
- Use the CONTROL wheel to select routing. The ENTER key is now blinking.
- Press ENTER to activate the selected routing.

Dual S/R - Dual Send/Return

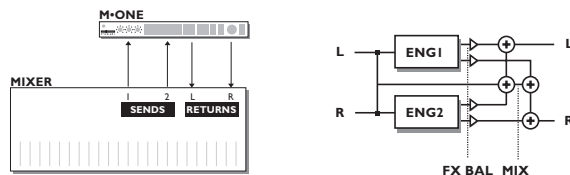

This is the routing to use if you wish to use the M•ONE as two independent effects processors. Left Input is sent to Engine 1 and right Input is sent to Engine 2. The four FX Outputs are summed to two channels.

EFFECT BAL

Controls the balance between the two Engine's FX Outputs.

MIX

Controls the amount of dry signal passed around the two Engines. Dry signal is passed in mono. Set MIX fully clockwise when using the M•ONE in a send/return setup.

Example:

Feed the two M•ONE Engines with signal from e.g. two separate Aux.'s from your mixer. Connect the M•ONE L/R Output to a stereo L/R return on your mixer.

You are now using the two Engines in the M•ONE as separate stereo effects with a common 2 channel Output.

Parallel

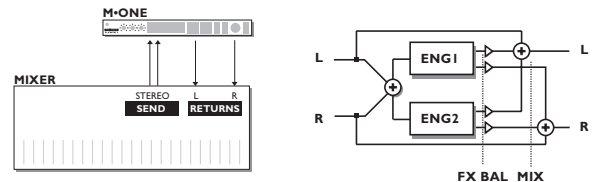

The Parallel routing sums left/right Inputs, and both Engines are fed with the exact same signal. As illustrated the unprocessed dry signal is mixed with the processed signal into two channels via the Mix parameter.

EFFECT BAL

Controls the balance between the two Engine's FX Outputs.

MIX

Controls the amount of dry signal passed around the two Engines. Dry signal is passed in stereo.



TIP The Parallel routing is perfect when you want to add two different effects to the same source.

Example:

You need a Chorus and a Reverb on the same guitar track. Select the Chorus in Engine 1, the Reverb in Engine 2 and the Parallel Routing. Now you have your two effects side by side, not influencing each other.

ROUTINGS

Parallel/Serial

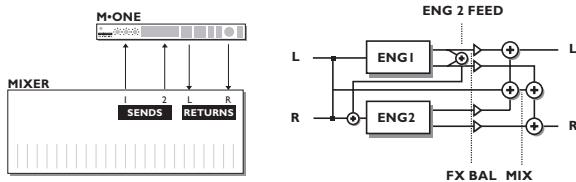

Parallel-Serial

The Parallel-Serial routing is similar to the Dual Input routing except for one thing: The Output of Engine 1 can be fed back to Engine 2's Input. This enables you to e.g. add reverb to the repeats of a delay. The amount of signal that is fed to Engine 2 is controlled by the Eng 2 Crossfeed parameter. The Eng 2 Crossfeed parameter is found in the Routing menu and is part of the preset.

EFFECT BAL

Controls the balance between the two Engine's FX Outputs.

MIX

Controls the amount of dry signal passed around the two Engines. Dry signal is passed in mono.

Eng2 Feed

Controls the amount of signal passed from the Output of Eng 1 to the Input of Eng 2. This parameter is only active in the Parallel-Serial routing.



The Parallel-Serial can be used when you want separate Inputs on the two Engines, but still want the two effects to be partially combined.

Example:

You have a long Delay running in Engine 1, and a large Hall Reverb on Engine 2. Both effects are used for the lead vocal. The level of the two effects are determined by two independent auxiliary sends from your mixing console. The repeats from the Delay seems kind of dry when compared the reverberated vocal, so now you bleed a bit of the Delay repeats from Engine 1 into the Reverb in Engine 2 by turning up the Eng 2 Feed parameter. Now both the Vocal and the Delay repeats are reverberated.

Serial

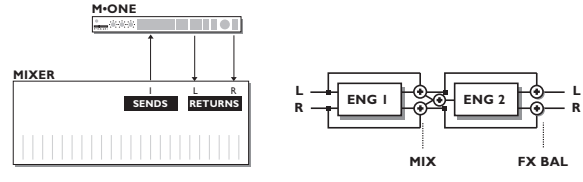

Serial

In Serial mode the signal always passes Engine 1 before Engine 2. On the front panel the EFFECT BAL knob and the MIX knob works as follows:

MIX

In Serial routing, the MIX knob work as the Mix control of Engine 1.

EFFECT BAL

Controls the level of dry signal passed around Engine 2. Please note that the "Dry" signal that passes Eng 2 is picked up after Engine 1. This makes it possible to emulate two stand alone effects in a serial setup. Dry signal is passed in stereo.



Use the Serial mode when you want to combine the Engines to one effect.

Example:

Select the De-esser in Engine 1, and a bright Reverb in Engine 2. The De-esser will now suppress the "Sss" sounds of a vocal, enabling you to use bright and open Reverbs without getting too much sibilance.

ROUTINGS

Stereo Linked

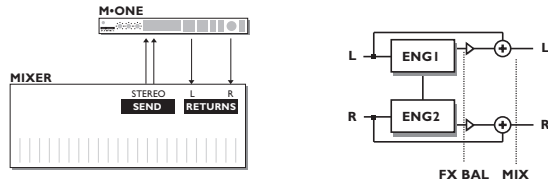

In the Stereo Linked Routing the Engines perform the exact same effect with synchronized parameter settings. Left I/O are used for Engine 1, Right I/O are used for Engine 2. When switching to Stereo Linked Routing the Engine 1 settings are forced into Engine 2.

EFFECT BAL.

Controls the balance between the two Engine's FX Outputs.

MIX

Controls the amount of dry signal passed around the two Engines. Dry signal is passed in stereo.



The Stereo Linked routing can be used for a true stereo application.

Example:

Select the Compressor and insert the M•ONE on a sub-group on your mixing console. Now you have a true stereo compressor with identical settings, and you only have to edit one Engine to change the settings of both channels.

Dual Mono

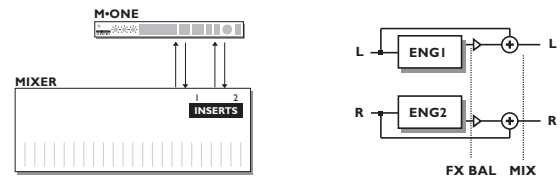

In the Dual Mono routing, the two Engines are totally independent, meaning mono in/mono out of each Engine. Left I/O are used for Engine 1, Right I/O are used for Engine 2.

EFFECT BAL.

Controls the balance between the two Engine's FX Outputs.

MIX

Controls the amount of dry signal passed around the two Engines. Dry signal is passed independently for the two channels.



Dual Mono is a great routing for independent Mono use. This enables you to use the two Engines for two totally different purposes.

Example:

You need a Tremolo and an EQ for inserting on two different channels.

Connect the first channel to Left In/Out of the M•ONE, and the second channel to right In/Out, select the Tremolo and the EQ, and you are up and running.

RECALL

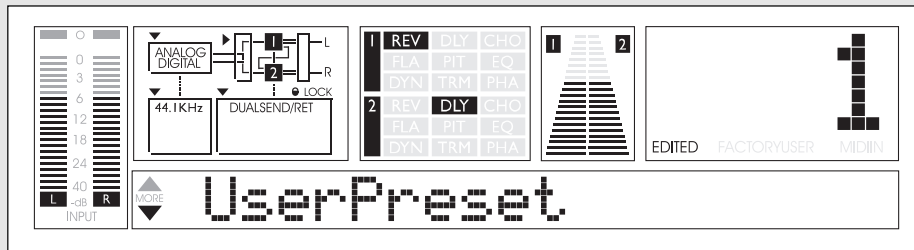

Recall

Recalling a Preset

Recalling a preset means loading/activating a preset.

- Press RECALL to enter the RECALL menu.
- Use the CONTROL wheel to preview presets.
Preview mode is indicated by blinking preset number and simultaneously blinking LED in the ENTER key.
- Press ENTER or RECALL to recall/activate the preset.

Press the EXIT key during a preview to return to the current recalled preset.

Preset types

User presets - RAM

User presets that can be edited and stored in any User location. You can store up to 100 user presets in the User bank.

Factory presets - ROM

Factory presets that can be edited and stored in any User location. You cannot store presets into a Factory location. The M•ONE holds 100 factory presets.



When you are in the Factory bank you can press the ARROW UP key to quickly enter the User bank. Likewise you can quickly enter the Factory preset bank by pressing the ARROW DOWN key.

STORE

Preset types

User presets - RAM

User presets that can be edited and stored in any User location. You can store up to 100 user presets in the User bank.

Factory presets - ROM

Factory presets that can be edited and stored in any User location. You cannot store presets into a Factory location. The M•ONE holds 100 factory presets.

Basic operation:

Press the STORE key to enter the Store page. The ENTER key and the preset number will be blinking indicating that the current preset has not yet been stored.

Preset Locations

Presets can be stored in User locations only. The Store page automatically suggests the first free User location in the memory as storing space unless the currently recalled preset is a User preset. In this case the same User location is suggested.

Storing an edited preset with the same name at the same location

- Press STORE to enter the Store menu.
- Press ENTER to store the preset. The display reads "Stored" shortly and returns to the Recall page.

Storing a preset with the same name at a new location

- Press STORE to enter the Store menu.
- Use the CONTROL wheel to select storing location.
- Press ENTER once to store the preset, the display reads "Stored" shortly and returns to the Recall page.

Storing a preset with a new name

- Press STORE to enter the Store menu.
- Select storing location using the CONTROL wheel.
- Press the STORE key again or the ARROW DOWN key to enter the "Naming" display.
- Use the ARROW keys to change cursor position.
- Dial the CONTROL wheel to select characters.
- Press ENTER to store the preset.

Available characters: ABCDEFGHIJKLMNOPQRSTUVWXYZ abcdefghijklmnopqrstuvwxyz 0123456789 /*-:."#\$%&()_

TAP

The TAP function allows you to tap a global tempo into the M•ONE. This tempo can be used for Delay time, Chorus rate etc.

Basic operation

- Press the TAP key once to enter the Tap menu.
 - Use the ARROW keys to select parameters.
 - Use the CONTROL wheel to select values.
- Changes are instantly effective.

Tap

Shows the currently entered Tap tempo. The tempo is shown in either ms (milliseconds) or BPM (Beats Per Minute).

Tap Subdivision

The subdivision determines how the M•ONE should respond to the tapped tempo. Options are: Ignored, 1, 1/2D, 1/2, 1/2T, 1/4D, 1/4, 1/4T, 1/8D, 1/8, 1/8T, 1/16D, 1/16, 1/16T, 1/32D, 1/32, 1/32T,

Tap Func

Sets what Engine the Tap control is working on. Range: Eng 1, Eng 2 or Eng 1&2.



You must select "Ignored" in "Tap Subdivision" to switch off the Tap function.

MIDI Sync

When MIDI Sync is enabled the M•ONE will lock to any incoming MIDI clock. Eg. when hooked up to a sequencer.



When MIDI Sync is enabled the Tap display will default to Subdivision indication.

REVERB - Hall

The Reverbs

Most of the Reverbs in the M•ONE contains two different parts; the Reflections and the Tail.

- The Reflections, or Early Reflections, simulate the first reflections that are heard. In real life, this is the part of a Reverb that defines the size and character of the room.
- The other part of the Reverb is known as the Reverb Tail or the diffused field. These reflections are so complex and disordered that you can no longer determine the actual direction of the original source.

In conjunction the two parts create the natural sound of an environment, however in real life the balance between these two parts of a Reverb may vary quite a bit. Therefore we provided controls that allow you to change the level, color and duration or size of the two.

Please try to experiment with the two parts of the Reverbs, and we guarantee that you will hear some astonishing effects.

Hall

Decay

Range: 0.02s - 20sec

The Decay parameter determines the length of the Reverb Tail. The length is defined as the time it takes for the Reverb Tail to decay approximately 60dB.

Predelay

Range: 0 - 100ms

A short delay placed between the Early Reflections and the Tail of the reverb. By using predelay the source material is kept clear and undisturbed by the more diffuse reverb tail.



Try to turn down the Reflect Level in order to achieve the traditional "slapback" effect on the Reverb Tail.

Size

Range: Small - Medium - Large

This parameter determines the size of the Early Reflection pattern. Try experimenting with the different sizes to hear what suits your source material best.

High Cut

Range: 501.2Hz - 20kHz

Rolls off high frequencies with a slope of 6dB/octave. Use this to remove sibilance in the Reverb.



Try experimenting with the difference in removing high frequencies using the High Cut and the High Color parameters.

High Color

Range: -50 - +50

This parameter adjusts the Decay time in the upper frequency spectra. By decreasing the upper frequency Decay time you remove sibilance while preserving the openness of the Reverb.

Low Color

Range: -50 - +50

This parameter adjusts the Decay time in the lower frequency spectra. Remove rumble while preserving the warmth of the Reverb Tail by decreasing the lower frequency Decay time.

Reflect Level

Range: 0dB to -100dB

This parameter adjusts the level of the Early Reflection.



Many older Reverbs did not utilize Early Reflection patterns. Try lowering the Reflect Level in order to achieve this character.

Reverb Level

Range: 0dB to -100dB

This parameter adjusts the Reverb Tail level. Lowering the Reverb Level will give you a more ambient sound, since the Early Reflection patterns will become more obvious.

REVERB - Room

Mod Type

Range: Off - Smooth - Vintage

Sets the Type of Modulation used on the Reverb Tail.

Smooth: The Smooth modulation uses a complicated modulation pattern, that allows the Reverb Tail to be modulated without detuning the original source signal.

Vintage: Many older reverbs used a very simple modulation pattern that tended to detune the original source slightly. The Vintage modulation is an emulation of this old modulation style, giving you the traditional detuning effect in the ringout of the reverb.

Mod Speed

Range: -25 - +25

Sets the speed of the modulation. The speed has been optimized for each Reverb type. The +/-25 range is calculated as the variation from this optimal setting.

Mod Depth

Range: -25 - +25

Sets the depth of the Modulation. The Depth has been optimized for each Reverb type. The +/-25 range is calculated as the variation from this optimal setting.

FX Level

Range: 0 - 100%

The level of the entire effect.

Room

Decay

Range: 0.02s - 2,5s

The Decay parameter determines the length of the Reverb Tail. The length is defined as the time it takes for the Reverb Tail to decay approx 60dB.

Predelay

Range: 0 - 100ms

A short delay placed between the Early Reflections and the Tail of the reverb. By using predelay the source material is kept clear and undisturbed by the more diffuse reverb tail.



Try to turn down the Reflect Level in order to achieve the traditional "slapback" effect on the Reverb Tail.

Size

Range: Small - Medium - Large

This parameter determines the size of the Early Reflection pattern. Try experimenting with the different sizes to hear what suits your source material best.

High Cut

Range: 501.2Hz - 20kHz

Rolls off high frequencies with a slope of 6dB/octave. Use this to remove sibilance in the Reverb.



Try experimenting with the difference in removing high frequencies using the High Cut and the High Color parameters.

High Color

Range: -50 - +50

This parameter adjusts the Decay time in the upper frequency spectra. By decreasing the upper frequency Decay time you remove sibilance while preserving the openness of the Reverb.

Low Color

Range: -50 - +50

This parameter adjusts the Decay time in the lower frequency spectra. Remove rumble while preserving the warmth of the Reverb Tail by decreasing the lower frequency Decay time.

REVERB - Room & Plate

Reflect Level

Range: 0dB to -100dB

This parameter adjusts the level of the Early Reflections.



Many older Reverbs did not utilize Early Reflection patterns. Try lowering the Reflect Level in order to achieve this character.

Reverb Level

Range: 0dB to -100dB

This parameter adjusts the Reverb Tail level. Lowering the Reverb Level will give you a more ambient sound, since the Early Reflection patterns will become more obvious.

Mod

Range: Off - On

Modulating the Reverb tail will create a more chaotic Reverb Tail, very similar to a natural room.

Mod Speed

Range: -25 - +25

Sets the speed of the modulation. The speed has been optimized for each Reverb type. The +/-25 range is calculated as the variation from this optimal setting.

Mod Depth

Range: -25 - +25

Sets the depth of the Modulation. The Depth has been optimized for each Reverb type. The +/-25 range is calculated as the variation from this optimal setting.

FX Level

Range: 0 - 100%

The level of the entire effect.

Plate 1

Decay

Range: 0.02s - 20s

The Decay parameter determines the length of the Reverb Tail. The length is defined as the time it takes for the Reverb Tail to decay approx 60dB.

Predelay

Range: 0 - 100ms

A short delay placed between the Early Reflections and the Tail of the reverb. By using predelay the source material is kept clear and undisturbed by the more diffuse reverb tail.



Try to turn down the Reflect Level in order to achieve the traditional "slapback" effect on the Reverb Tail.

Size

Range: Small - Medium - Large

This parameter determines the size of the Early Reflection pattern. Try experimenting with the different sizes to hear what suits your source material best.

High Cut

Range: 501.2Hz - 20kHz

Rolls off high frequencies with a slope of 6dB/octave. Use this to remove sibilance in the Reverb.



Try experimenting with the difference in removing high frequencies using the High Cut and the High Color parameters.

High Color

Range: -50 - +50

This parameter adjusts the Decay time in the upper frequency spectra. By decreasing the upper frequency Decay time you remove sibilance while preserving the openness of the Reverb.

REVERB - Plate

Low Color

Range: -50 - +50

This parameter adjusts the Decay time in the lower frequency spectra. Remove rumble while preserving the warmth of the Reverb Tail by decreasing the lower frequency Decay time.

Reflect Level

Range: 0dB to -100dB

This parameter adjusts the level of the Early Reflections.



Many older Reverbs did not utilize Early Reflection patterns. Try lowering the Reflect Level in order to achieve this character.

Reverb Level

Range: 0dB to -100dB

This parameter adjusts the Reverb Tail level. Lowering the Reverb Level will give you a more ambient sound, since the Early Reflection patterns will become more obvious

Mod Speed

Range: -25 - +25

Sets the speed of the modulation. The Speed has been optimized for each Reverb type. The +/-25 range is calculated as the variation from this optimal setting.

Mod Depth

Range: -25 - +25

Sets the depth of the Modulation. The Depth has been optimized for each Reverb type. The +/-25 range is calculated as the variation from this optimal setting.

FX Level

Range: 0 - 100%

The level of the entire effect.

Plate 2

Decay

Range: 0.02s - 20s

The Decay parameter determines the length of the Reverb Tail. The length is defined as the time it takes for the Reverb Tail to decay approximately 60dB.

Predelay

Range: 0 - 100ms

A short delay placed between the Early Reflections and the Tail of the reverb. By using predelay the source material is kept clear and undisturbed by the more diffuse reverb tail.



Try to turn down the Reflect Level in order to achieve the traditional "slapback" effect on the Reverb Tail.

Size

Range: Small - Medium - Large

This parameter determines the size of the Early Reflection pattern. Try experimenting with the different sizes to hear what suits your source material best.

High Cut

Range: 501.2Hz - 20kHz

Rolls off high frequencies with a slope of 6dB/octave. Use this to remove sibilance in the Reverb.



Try experimenting with the difference in removing high frequencies using the High Cut and the High Color parameters.

High Color

Range: -50 - +50

This parameter adjusts the Decay time in the upper frequency spectra. By decreasing the upper frequency Decay time you remove sibilance while preserving the openness of the Reverb.

Low Color

Range: -50 - +50

This parameter adjusts the Decay time in the lower frequency spectra. Remove rumble while preserving the warmth of the Reverb Tail by decreasing the lower frequency Decay time.

REVERB - Spring

Reflect Level

Range: 0dB to -100dB

This parameter adjusts the level of the Early Reflections.



Many older Reverbs did not utilize Early Reflection patterns. Try lowering the Reflect Level in order to achieve this character.

Reverb Level

Range: 0dB to -100dB

This parameter adjusts the Reverb Tail level. Lowering the Reverb Level will give you a more ambient sound, since the Early Reflection patterns will become more obvious

Mod

Range: Off - On

Modulating the Reverb tail will create a more chaotic Reverb Tail, very similar to a natural room.

Mod Speed

Range: -25 - +25

Sets the speed of the modulation. The Speed has been optimized for each Reverb type. The +/-25 range is calculated as the variation from this optimal setting.

Mod Depth

Range: -25 - +25

Sets the depth of the Modulation. The Depth has been optimized for each Reverb type. The +/-25 range is calculated as the variation from this optimal setting.

FX Level

Range: 0 - 100%

The level of the entire effect.

Spring

A reverb algorithm designed to reproduce the sound of the old spring reverbs, such as the ones used in vintage guitar amps.

Decay

Range: 0.02s - 20s

The Decay parameter determines the length of the Reverb Tail. The length is defined as the time it takes for the Reverb Tail to decay approximately 60dB.

Predelay

Range: 0 - 100ms

A short delay placed between the direct signal and the Tail of the reverb. By using predelay the source material is kept clear and undisturbed by the more diffuse reverb tail.

High Cut

Range: 501.2Hz - 20kHz

Rolls off high frequencies with a slope of 6dB/octave. Use this to remove sibilance in the Reverb.



Try experimenting with the difference in removing high frequencies using the High Cut and the High Color parameters.

High Color

Range: -50 - +50

This parameter adjusts the Decay time in the upper frequency spectra. By decreasing the upper frequency Decay time you remove sibilance while preserving the openness of the Reverb.

Low Color

Range: -50 - +50

This parameter adjusts the Decay time in the lower frequency spectra. Remove rumble while preserving the warmth of the Reverb Tail by decreasing the lower frequency Decay time.

FX Level

Range: 0 - 100%

The level of the entire effect.

REVERB - Live

Live

Decay

Range: 0.02s - 20s

The Decay parameter determines the length of the Reverb Tail. The length is defined as the time it takes for the Reverb Tail to decay approximately 60dB.

Predelay

Range: 0 - 100ms

A short delay placed between the Early Reflections and the Tail of the reverb. By using predelay the source material is kept clear and undisturbed by the more diffuse reverb tail.



Try to turn down the Reflect Level in order to achieve the traditional "slapback" effect on the Reverb Tail.

Size

Range: Small - Medium - Large

This parameter determines the size of the Early Reflection pattern. Try experimenting with the different sizes to hear what suits your source material best.

High Cut

Range: 501.2Hz - 20kHz

Rolls off high frequencies with a slope of 6dB/octave. Use this to remove sibilance in the Reverb.



Try experimenting with the difference in removing high frequencies using the High Cut and the High Color parameters.

High Color

Range: -50 - +50

This parameter adjusts the Decay time in the upper frequency spectra. By decreasing the upper frequency Decay time you remove sibilance while preserving the openness of the Reverb.

Low Color

Range: -50 - +50

This parameter adjusts the Decay time in the lower frequency spectra. Remove rumble while preserving the warmth of the Reverb Tail by decreasing the lower frequency Decay time.

Reflect Level

Range: 0dB to -100dB

This parameter adjusts the level of the Early Reflection.



Many older Reverbs did not utilize Early Reflection patterns. Try lowering the Reflect Level in order to achieve this character.

Reverb Level

Range: 0dB to -100dB

This parameter adjusts the Reverb Tail level. Lowering the Reverb Level will give you a more ambient sound, since the Early Reflection patterns will become more obvious

Mod Speed

Range: -25 - +25

Sets the speed of the modulation. The speed has been optimized for each Reverb type. The +/-50 range is calculated as the variation from this optimal setting.

Mod Depth

Range: -25 - +25

Sets the depth of the Modulation. The Depth has been optimized for each Reverb type. The +/-50 range is calculated as the variation from this optimal setting.

FX Level

Range: 0 - 100%

The level of the entire effect.

REVERB - Ambience

Ambience

As opposed to the Spring reverb, the Ambience algorithm is a very natural sounding reverb.

Decay

Range: 0.02s - 2,5s

The Decay parameter determines the length of the Reverb Tail. The length is defined as the time it takes for the Reverb Tail to decay approximately 60dB.

Predelay

Range: 0 - 100ms

A short delay placed between the Early Reflections and the Tail of the reverb. By using predelay the source material is kept clear and undisturbed by the more diffuse reverb tail.



Try to turn down the Reflect Level in order to achieve the traditional “slapback” effect on the Reverb Tail.

Size

Range: Small - Medium - Large

This parameter determines the size of the Early Reflection pattern. Try experimenting with the different sizes to hear what suits your source material best.

High Cut

Range: 501.2Hz - 20kHz

Rolls off high frequencies with a slope of 6dB/octave. Use this to remove sibilance in the Reverb.



Try experimenting with the difference in removing high frequencies using the High Cut and the High Color parameters.

High Color

Range: -50 - +50

This parameter adjusts the Decay time in the upper frequency spectra. By decreasing the upper frequency Decay time you remove sibilance while preserving the openness of the Reverb.

Low Color

Range: -50 - +50

This parameter adjusts the Decay time in the lower frequency spectra. Remove rumble while preserving the warmth of the Reverb Tail by decreasing the lower frequency Decay time.

Reflect Level

Range: 0dB to -100dB

This parameter adjusts the level of the Early Reflection.



Many older Reverbs did not utilize Early Reflection patterns. Try lowering the Reflect Level in order to achieve this character.

Reverb Level

Range: 0dB to -100dB

This parameter adjusts the Reverb Tail level. Lowering the Reverb Level will give you a more ambient sound, since the Early Reflection patterns will become more obvious

Mod

Range: Off - On

Switches the Modulation function On/Off.

Modulating the Reverb tail will create a more chaotic Reverb Tail, very similar to a natural room.

Mod Speed

Range: -25 - +25

Sets the speed of the modulation. The Speed has been optimized for each Reverb type. The +/-25 range is calculated as the variation from this optimal setting.

Mod Depth

Range: -25 - +25

Sets the depth of the Modulation. The Depth has been optimized for each Reverb type. The +/-25 range is calculated as the variation from this optimal setting.

FX Level

Range: 0 - 100%

The level of the entire effect.

DELAY - One Tap & Two Tap

One Tap

The One Tap Delay mode operates with one delay line only.

Delay Time

Range: 0 - 4000ms

The length of the the Delay time.

Feedback

Range: -100 to +100

Controls the amount of signal that is routed back to the Input of the algorithm. The higher Feedback value the more repeats you will get.

Pan

Range: 50L - 50R

Controls the panning of the selected voice.

High Cut

Range: 500Hz - 20kHz

High Cut filter that allows you to reduce the high frequencies of the Delay Taps. This gives you softer and more analog sounding Delay Taps which in some cases will seem less disturbing in the overall sound, than a delay with no High Cut.

Low Cut

Range: 19.9Hz - 2kHz

Low Cut filter reducing the low end frequencies of the Delay Taps. When using delay on signals with low frequencies a full-range delay might introduce a less tight feeling in the low frequencies. Use the Low Cut filter to avoid this.

FX Level

Range: 0 - 100%

The over all level of the Delay.

Two Tap

The Two Tap Delay mode operates with two Taps, each with its own set of parameters.

Delay Time 1+2

Range: 0 - 4000ms

The Delay time of the Delay tap.

Offset

Range: 0-200ms

Offsets the Delay in the right Channel.

Feedback 1+ 2

Range: -100 to +100

Controls the amount of signal that is routed back to the Input of the algorithm. The higher the Feedback value the more repeats you will get.

Level 1+2

Range: -100 - 0dB

The level of the selected Tap.

Pan 1+2

Range: 50L - 50R

Controls the panning of the selected voice.

High Cut

Range: 500Hz - 20kHz

High Cut filter that allows you to reduce the high frequencies of the Delay Taps. This gives you softer and more analog sounding Delay Taps which in some cases will seem less disturbing in the overall sound than a delay with no High Cut.

Low Cut

Range: 19.9Hz - 2kHz

Low Cut filter reducing the low end frequencies of the Delay Taps. When using delay on signals with low frequencies a full-range delay might introduce a less tight feeling in the low frequencies. Use the Low Cut filter to avoid this.

FX Level

Range: 0 - 100%

The overall level of the Delay.

CHORUS - Classic & 4-Voice

Classic

A Chorus/Flanger is basically a delay being pitch-modulated by an LFO (Low Frequency Oscillator).

The M•ONE Classic Chorus is based on 2 voices and produces a smooth natural sounding chorus.

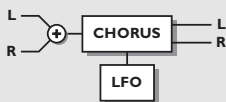

Speed

Range: 0.05 - 19.2Hz

The Speed of the Chorus. Also known as "Rate".

Depth

Range: 0 - 100%

The Depth of the Chorus. Also known as "Intensity".

Delay

Range: 0 - 100ms

A Chorus is basically a delay being pitch-modulated by an LFO (Low Frequency Oscillator). The typical Delay time used in a Chorus is around 10ms.

FX Lev

Range: 0 -100%

The level of the Chorus effect.

4-Voice

The 4-voice Chorus is based on two Classic Chorus blocks connected in serial, phase-reversed and with a fixed Delay time. This gives you twice the amount on "voices" and produces a much thicker sounding Chorus effect compared to the Classic algorithm.

Speed

Range: 0.05 - 19.2Hz

The speed of the Chorus. Also known as "Rate".

Depth

Range: 0 - 100%

The depth of the Chorus. also known as "Intensity".

FX Lev

Range: 0 -100%

The level of the Chorus effect.

FLANGE - Classic & 4-Voice

Classic

A Chorus/Flanger is basically a delay being pitch-modulated by an LFO (Low Frequency Oscillator).

The M•ONE Classic Flanger is based on 2 voices.

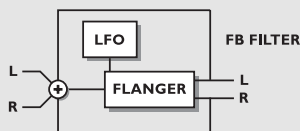

Speed

Range: 0.05 - 19.2Hz

The speed of the Flanger. Also known as "Rate".

Depth

Range: 0 - 100%

The depth of the Flanger. also known as "Intensity".

Feedback

Range: -100 to +100

The amount of processed signal that is fed back to the Input of the algorithm. When the feedback value is negative, the Feedback signal is phase reversed.

Delay

Range: 0 - 100ms

The typical delay used in a Flanger is around 5ms.

FX Lev

Range: 0 -100%

The level of the Flanger effect.

4-Voice

The 4-voice Flanger is based on two Classic Flanger blocks connected in serial, phase-reversed and with a fixed Delay time. This gives you twice the amount on "voices" and produces a much thicker sounding Flange effect compared to the Classic algorithm.

Speed

Range: 0.05 - 19.2Hz

The speed of the Flanger. Also known as "Rate".

Depth

Range: 0 - 100%

The depth of the Flanger. also known as "Intensity".

Feedback

Range: -100 - 100

The amount of processed signal that is fed back to the Input of the algorithm. When the feedback value is negative, the Feedback signal is phase reversed.

FX Lev

Range: 0 -100%

The level of the Flanger effect.

PITCH - Detune & Pitch Shift

Pitch Detune

Pitch Detune is similar to the Pitch algorithm meaning that a fixed voice is added to the signal. However the range in a Detune algorithm is considerably lower and is often used to create a wide sound as opposed to a second voice.

By using approx. 5-10 cent of Detune amount you will get a chorus sounding effect without the modulating/swirling motion that is so characteristic for the chorus, but in some cases disturbs the clarity of the sound.

Pitch 1+2

Range: -50 - 50 cent

The pitch value of the selected voice.

Level 1+2

Range: -100 - 0dB

The level of the selected voice.

Pan 1+2

Range: 50L to 50R

Controls the panning of the selected voice.

Delay 1+2

Range: 0 - 100ms

The Delay time of the selected voice.

FX Level

Range: 0 - 100%

The level of the entire effect.

Pitch Shift

The M•ONE Pitch algorithm allows you to add 2 separate fixed voices to the source signal. In the following parameter description these are referred to as 1 and 2.



Pitch 1

Range: -1200 - 1200 cent

Determines the pitch value of the first fixed voice.

As 100 cent is one semitone you are able to add a second voice withing the range of +/- one whole octave.

Level 1

Range: -100 - 0dB

The level of the added voice.

Pan 1

Range: 50L to 50R

Controls the panning of the first voice.

Delay 1

Range: 0 - 100ms

The Delay time of the added voice.

Pitch 2

Range: -1200 - 1200 cent

Determines the pitch value of the second fixed voice.

Level 2

Range: -100 - 0dB

The level of the second added voice.

Pan 2

Range: 50L to 50R

Controls the panning of the second voice.

Delay 2

Range: 0 - 100ms

The Delay time of the added voice.

FX Lev

Range: 0 - 100%

The Level of the entire effect.

PARAMETRIC EQUALIZER

The M•ONE Equalizer is a three band parametric type with an additional high and low shelving band.

Low Shelving Band:

Low Freq

Range: 19.95Hz to 5.01kHz

Sets the target-frequency for the Low shelving band.

Low Slope

Range: 3dB/oct - 12dB/oct

The Low Slope parameter sets the steepness of the Low Shelving Band curve.

Low Gain

Range: -12dB - 12dB

The cut or boost of the Low shelving Band.

Parametric Filters:

Freq 1

Range: 19.95Hz to 20kHz

The target frequency for the first of the three EQ bands.

BndWdth 1 - Bandwidth 1

Range: 0.1oct - 4oct

The Bandwidth of the first EQ band.

Gain 1

Range: -12dB - 12dB

The cut or boost of this band.

Freq 2

Range: 19.95Hz to 20kHz

The target frequency for the second of the three EQ bands.

BndWdth 2 - Bandwidth 2

Range: 0.1oct - 4oct

The Bandwidth of the second EQ band.

Gain 2

Range: -12dB - 12dB

The cut or boost of this band.

Freq 3

Range: 19.95Hz to 20kHz

The target frequency for the third of the three EQ bands.

BndWdth 3 - Bandwidth 3

Range: 0.1oct - 4oct

The Bandwidth of the third EQ band.

Gain 3

Range: -12dB - 12dB

The cut or boost of this band.

High Shelving Band:

High Freq

Range: 501.2Hz - 20kHz

Sets the target frequency for the High Shelving Band.

High Slope

Range: 3dB/oct - 12dB/oct

The High Slope parameter sets the steepness of the High Shelving Band curve.

High Gain

Range: -12dB - 12dB

The cut or boost of the High Shelving Band.

FX Level

Range: 0 - 100%

The overall Output level of the Equalizer.

DYNAMICS - Compressor & Limiter

Compressor

A compressor is meant to reduce the dynamic content of the Input signal and thereby keep the signal at a more constant level.

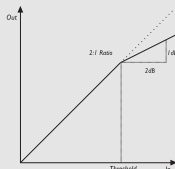

Threshold

Range: -60 - 0dB

When the Input signal exceeds the Threshold the Compressor will be activated. So, the lower the Threshold the more compression you will get.

Ratio

Range: Off - inf: 1

The Ratio of the gain reduction. On the illustration this is the angle of the line above the Threshold point.

Example. If the Ratio is set to 4:1 it means that for every 4dB the Input level rises above the set Threshold only one dB is Output.

Knee Mode

Range: Soft or Hard

The Knee mode sets the bending point of the Compressor. When Soft knee mode is selected, the Compressor will gradually reach the Ratio, while Hard knee mode will cause the Compressor to go directly from no compression to the specified Ratio.

Release

Range: 10 - 100dB/sec.

Determines the time the Compressor uses to reach a gain reduction of 1:1 (no reduction) once the Input signal has dropped below the Threshold.

Gain

Range: -100 - +30dB

Use the Gain parameter to compensate for unwanted gain reduction caused by heavy compression.

FX Level

Range: 0 - 100%

The Output level of the Compressor

Limiter

A Limiter can be conceived as a compressor with a high Ratio setting. It is primarily used to prevent fullscale overloads. A fullscale overload means hitting 0dBFS, which is the absolute max in the digital domain, and it causes a clipped and distorted signal.

Threshold

Range: -60dB - 0dB

When the Input signal exceeds the Threshold the Limiter will be activated. So, the lower the Threshold the more limiting you will get.

Ratio

Range: Off - inf: 1

The Ratio of the gain reduction. On the illustration it is the angle of the line above the Threshold point.

Example. If the Ratio is set to 4:1 it means that for every 4dB the Input level rises above the set Threshold only 1dB is output.

Attack

Range: 0.3ms - 100ms

The time it takes for the Limiter to reach the gain reduction specified by the Ratio parameter when the signal is above the set Threshold.

Release:

Range: 20ms - 7.0 sec

Release is the time that the Limiter uses to release the gain reduction when the signal exceeds the Threshold.

Gain

Range: -100dB - 30dB

Use the Gain parameter to compensate for unwanted gain reduction caused by heavy limiting.

FX Level

Range: 0 - 100%

The Output level of the Limiter.

DYNAMICS - Gate/Expander

Gate

A Gate is also known as a "downward expander". Meaning that when the signal drops below a set Threshold the gate will "close" and thereby mute the signal. This is especially useful when trying to remove unwanted background noise from source material that is only periodically present. This can be anything from vocal tracks to noisy guitar-amps. You can even use it on drums to add a more percussive feeling to the track.

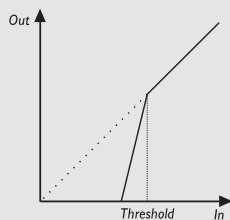

Threshold

Range: -60 - 0dB

When the Input signal falls below the Threshold, the Gate starts working. This means that the higher Threshold the more gating you will get.

Ratio

Range: Off - Inf:1

This is the Ratio of the gain reduction. If the Ratio is set to 4:1 it means that for every 1dB the Input signal decreases, the Output will decrease by 4dB.

When the Ratio is set to Infinite:1, it means that when the Input signal falls below the Threshold, the Output is turned all the way down.

Attack

Range: 0.5 - 100ms

The Attack time is the fallback time that the Gate uses to reach the gain reduction specified by the Ratio parameter.

Example: If the Input signal suddenly drops 4dB below Threshold in no time, with the Ratio set to 4:1 and the Attack set to 20ms, the M•ONE will use 20ms to reach a total gain reduction of 16dB.

Release:

Range: 20ms - 7 sec.

Release is the time that the Gate uses to release the gain reduction when the signal exceeds the Threshold.

FX Lev

Range: 0 - 100%

The Output level of the Gate.

DYNAMICS - De-esser

De-esser

A De-esser is used to remove sibilant sounds from various instruments - especially voices. To remove only the unwanted (most significant) "esses" a De-esser must work dynamically. It could therefore be compared to Compressor working on a specific frequency area only. A dynamic filter ensures that the De-esser only reduces the high frequencies when they are too loud.

Threshold

Range: -60dB - 0dB

When the Input level for the specified frequency area exceeds this level the De-esser will be activated.

Ratio

Range: Off - inf:1

The Ratio of the gain reduction in the specified frequency area.

Frequency

Range: 1kHz - 20kHz

Sets the center frequency for the area in which the De-esser should work.

Attack

Range: 0.5 - 50ms

The Attack time is the response time that the De-esser uses to reach the gain reduction specified by the Ratio parameter.

Example: If the Input signal suddenly increases to 4dB above Threshold with the Ratio set to 4:1 and the Attack set to 20ms, the De-esser will use 20ms to reach the gain reduction of 3dB.

Release:

Range: 20ms - 7 sec.

Release is the fallback time of the De-esser, after the signal drops below the Threshold.

FX Lev

Range: -100 - 0dB

The Output level of the De-esser.

Tremolo - Hard & Soft

Tremolo

A tremolo is basically an identical level change in left and right channels. This effect is typically heard on guitar tracks or tracks where old Wurlitzer E-Pianos are used.

Hard

The Hard Tremolo mode produces the most aggressive type of tremolo.



Speed

Range: 0.05 - 19.2Hz

The Speed of the Tremolo.

Depth

Range: 0 - 100%

The Depth of the Tremolo.

FX Lev

Range: 0 - 100%

The level of the Tremolo effect.

Soft

The Soft Tremolo mode is softer sounding than the Hard mode as the signal is only at its peaks for a short while.



Speed

Range: 0.05 - 19.2Hz

The Speed of the Tremolo.

Depth

Range: 0 - 100%

The Depth of the Tremolo.

FX Lev

Range: 0 - 100%

The level of the Tremolo effect.

PHASER - Vintage & Smooth

Vintage

The Vintage Phaser utilizes four All-pass filters. These filters creates a comb looking characteristic. When the filtered sound is mixed with the direct sound the “phasing sound” occurs.

Speed

Range: 0.05 - 19.2Hz
The Speed of the Phaser.

Depth

Range: 0 - 100%
The Depth of the Phaser.

Range

Range: Low or Mid
The Range parameter determines the frequency area in which the Phaser is operating.

Feedback

Range: -100 - 100%
The amount of processed signal that is fed back to the Input of the effect block. When the Feedback value is negative, the Feedback signal is phase reversed.



Try experimenting with the reversed phase Feedback.

FX Lev

Range: 0 - 100%
The level of the Phaser effect.

Smooth

The Smooth Phaser utilizes twelve All-pass filters. These filters creates a comb looking characteristic. When the filtered sound is mixed with the direct sound, the “phasing sound” occurs. Due to the higher number of filters this version of the Phaser sounds smoother than Vintage.

Speed

Range: 0.05 - 19.2Hz
The Speed of the Phaser.

Depth

Range: 0 - 100%
The Depth of the Phaser.

Range

Range: Low or High
The Range parameter determines the frequency area in which the Phaser is operating.

Feedback

Range: -100 - 100%
The amount of processed signal that is fed back to the Input of the effect block.



Try experimenting with the reversed phase Feedback.

FX Lev

Range: 0 - 100%
The level of the Phaser effect.

IMPORTANT SAFETY INSTRUCTIONS

Please read, keep, and follow these instructions before connecting this unit. Heed all warnings and instructions. Retain this notice and the owner's manual for future reference.



The lightning flash with an arrowhead symbol within an equilateral triangle, is intended to alert the user to the presence of uninsulated "dangerous voltage" within the product's enclosure that may be of sufficient magnitude to constitute a risk of electric shock to persons.



The exclamation point within an equilateral triangle is intended to alert the user to the presence of important operating and maintenance (servicing) instructions in the literature accompanying the product.

Warning!

- To reduce the risk of fire or electric shock, do not expose this unit to rain or moisture.
- Do not open the unit - risk of electric shock inside.
- This apparatus must be earthed.
- Use a three wire grounding type line chord like the one supplied with the product.
- Be advised that different operating voltages require the use of different types of line cord and attachment plugs. If in doubt please contact your TC distributor.
- Check the voltage in your area and use the correct type. See table below:

Voltage	Line plug according to standard.
110-125V	UL817 and CSA C22.2 no 42.
220-230V	CEE 7 page VII, SR section 107-2-D1/IEC 83 page C4.
240V	BS 1363 of 1984. Specification for 13A fused plugs and switched and un-switched socket outlets.

- Mount in a well ventilated rack with a little space above and below.
- This equipment should be installed near the socket outlet and disconnection of the device should be easily accessible.
- Do not install near heat source, such as radiators, heat registers, stoves or other apparatus. (including amplifiers) that produce heat.
- Do not rely solely on the front screws when mounted in touring rack. Support the back as well.
- Clean only with a damp cloth.
- Do not defeat the safety purpose of a polarized or grounding type plug. A polarized plug has two blades with one wider than the other. A grounding type plug has two blades/prongs and a third grounding prong. The wide blade or the third prong are provided for your safety. When the provided plug does not fit into your outlet, consult an electrician for replacement of the obsolete outlet.
- Protect the power cord from being walked on or pinched particularly at plugs convenience receptacles, and the point where they exit from the apparatus.
- Only use attachments/accessories specified by the manufacturer.
- Unplug this apparatus during lightning storms or when unused for long periods of time.

IMPORTANT SAFETY INSTRUCTIONS

Service

There are no user-serviceable parts inside. All service must be performed by qualified personnel. Servicing is required when:

- the unit has been damaged in any way, such as when the power-supply cord or plug is damaged.
- the unit has been exposed to rain or moisture, or liquid has been spilled into the unit.
- objects have fallen into the unit .
- the unit does not work properly.
- the unit has been dropped.

This equipment has been tested and found to comply with the limits for a Class B Digital device, pursuant to part 15 of the FCC rules.

These limits are designed to provide reasonable protection against harmful interference in a residential installations. This equipment generates, uses and can radiate radio frequency energy and, if not installed and used in accordance with the instructions, may cause harmful interference to radio communications. However, there is no guarantee that interference will not occur in a particular installation.

If this equipment does cause harmful interference to radio or television reception, which can be determined by turning the equipment off and on, the user is encouraged to try to correct the interference by one or more of the following measures:

- Reorient or relocate the receiving antenna.
- Increase the separation between the equipment and receiver.
- Connect the equipment into an outlet on a circuit different from that to which the receiver is connected.
- Consult the dealer or an experienced radio/TV technician for help.

The user may find the following booklet, prepared by the Federal Communications Commission, helpful:

"How to identify and Resolve Radio/TV interference Problems."

This booklet is available from the US. Government Printing Office, Washington, DC 20402, Stock No. 004-000-0034-4.

Caution:

You are cautioned that any change or modifications not expressly approved in this manual could void your authority to operate this equipment.

For the customers in Canada:

This Class B Digital apparatus meets all requirements of the Canadian Interference-Causing Equipment Regulations. Cet appareil numérique de la classe B respecte toutes les exigences du Règlement sur le matériel brouilleur du Canada.

Certificate Of Conformity

TC Electronic A/S, Sindalsvej 34, 8240 Risskov, Denmark, hereby declares on own responsibility that following product:

M•ONE - Dual Effects Processor

- that is covered by this certificate and marked with CE-label conforms with following standards:

EN 60065 (IEC 60065)	Safety requirements for mains operated electronic and related apparatus for household and similar general use
EN 55103-1	Product family standard for audio, video, audio-visual and entertainment lighting control apparatus for professional use. Part 1: Emission.
EN 55103-2	Product family standard for audio, video, audio-visual and entertainment lighting control apparatus for professional use. Part 2: Immunity.

With reference to regulations in following directives: 73/23/EEC, 89/336/EEC

Issued in Risskov, November 1999

Anders Fauerskov
Chief Executive Officer

APPENDIX - MIDI Implementation Chart

DUAL EFFECTS PROCESSOR M•ONE - NOVEMBER - 1999

Function		Transmitted	Recognized	Remarks
Basic Channel	Default	1	1	
	Changed	1-16	1-16	
Mode	Default			
	Messages	X	X	
	Altered			
Note Number		X	X	
	True Voice	X	X	
Velocity	Note ON	X	X	
	Note OFF	X	X	
After Touch	Key's	X	X	
	Ch's	X	X	
Pitch Bend		X	X	
Control Change		from 16 and up	from 16 and up	Eng 1: 16-31 Eng 2: 48-63 System: 70-78 All Controllers are single byte type, scaled to parameter range.
Prog Change		O	O	
System Excl. Common		O	O	
	:Song Pos	X	X	
	:Song Sel	X	X	
System real time	:Tune	X	X	
	:Clock	X	O	
	:Commands	X	X	
Aux Messages	:Local ON/OFF	X	X	
	:All Notes OFF	X	X	
	:Active Sense	X	X	
	:Reset	X	X	
O: YES	Mode 1: OMNI ON, POLY	Mode 2: OMNI ON, MONO		
X: NO	Mode 3: OMNI OFF, POLY	Mode 4: OMNI OFF, MONO		

APPENDIX - Technical Specifications

Digital Inputs and Outputs

Connectors: RCA Phono (S/PDIF)
 Formats: S/PDIF (24 bit), EIAJ CP-340, IEC 958
 Output Dither: HPF/TPDF dither 24/20/16/8 bit
 Sample Rates: 44.1 kHz, 48 kHz
 Processing Delay: 0.1 ms @ 48 kHz
 Frequency Response DIO: DC to 23.9 kHz \pm 0.01 dB @ 48 kHz

Analog Inputs

Connectors: 1/4" phone jack, balanced
 Impedance, Bal / Unbal: 21 kOhm / 13 kOhm
 Max. Input Level: +24 dBu
 Min. Input Level for 0 dBFS: 0 dBu
 Sensitivity: @ 12 dB headroom: -12 dBu to +12 dBu
 A to D Conversion: 24 bit, 128 x oversampling bitstream
 A to D Delay: 0.65 ms / 0.70 ms @ 48 kHz / 44.1 kHz
 Dynamic Range: 100 dB typ, 20 Hz - 20 kHz
 THD: typ < 92 dB (0.0025 %) @ 1 kHz
 Frequency Response: +0/-0.1 dB @ 48 kHz, 20 Hz to 20 kHz
 Crosstalk: <-95 dB, 20 Hz to 20 kHz

Analog Outputs

Connectors: 1/4" phone jack, balanced
 Impedance Balanced / Unbalanced: 40 Ohm
 Max. Output Level: +20 dBu (balanced)
 Output Ranges: Balanced: 20/14/8/2 dBu
 Unbalanced: 14/8/2 dBu
 D to A Conversion: 24 bit, 128 x oversampling bitstream
 D to A Delay: 0.63 ms / 0.68 ms @ 48 kHz / 44.1 kHz
 Dynamic Range: 104 dB typ, 20 Hz to 20 kHz
 THD: typ <-94 dB (0.002 %) @ 1 kHz, +20 dBu Output
 Frequency Response: +0/-0.5 dB @ 48 kHz, 20 Hz to 20 kHz
 Crosstalk: <-100 dB, 20 Hz to 20 kHz

EMC

Complies with: EN 55103-1 and EN 55103-2
 FCC part 15, Class B, CISPR 22, Class B

Safety

Certified to: IEC 65, EN 60065, UL6500 and CSA E65

Environment

Operating Temperature: 32° F to 122° F (0° C to 50° C)
 Storage Temperature: -22° F to 167° F (-30° C to 70° C)
 Humidity: Max. 90 % non-condensing

Control Interface

MIDI: In/Out/Thru: 5 Pin DIN
 Pedal: 1/4" phone jack

General

Finish: Anodized aluminum front
 Plated and painted steel chassis

Display

Dimensions: 23 character / 280 icon STN-LCD display
 Weight: 19" x 1.75" x 8.2" (483 x 44 x 195 mm)
 4.1 lb. (1.85 kg)
 Mains Voltage: 100 to 240 VAC, 50 to 60 Hz (auto-select)
 Power Consumption: <15 W
 Warranty Parts and labor: 1 year

Technical Specifications are subject to change without notice !

APPENDIX - Troubleshooting

Problems sending and receiving MIDI information

You will need to reset the System Parameters! This is done via a System Parameter reset easily performed if you follow the procedure below.



The "System Parameter reset", restores the factory defaults in the I/O and Utility menu's.

The "System Parameter reset" does NOT erase any presets.

- Press and hold the ENTER key during power up.
 - Dial the CONTROL wheel until the display reads "Reset Sys Param".
 - Press the ENTER key to confirm.
 - After 2 seconds, the display reads "Clear/Reset done"
 - Power Off - On.
- The display reads "Kernel cleared" during the first power up.

The M•ONE System parameters are now reset and the MIDI port is fully functional.

PRESET LIST

- | | | | |
|----|------------------------|-----|------------------------|
| 1 | M-One halls | 51 | De-Essed Hall |
| 2 | Vintage Hall & Room | 52 | De-Essed Plate |
| 3 | Natural Hall + Ambient | 53 | Chorused Hall |
| 4 | vocal/Choir halls | 54 | Compresed Live verb |
| 5 | Vocal ambient & Hall | 55 | Compresed Room verb |
| 6 | Vocal Delay & Spring | 56 | Wet Chorus-Phaser |
| 7 | Vocal Hall/Ahort SN | 57 | Party Next Door |
| 8 | VOC Large/Med plate | 58 | Sund Check |
| 9 | VOC Amb &Liveverb | 59 | Aalog Style Delay |
| 10 | Large VOC Hall/Room | 60 | Detuned Tape Delay |
| 11 | Vocal Amb+ small Room | 61 | Filtered Octaver |
| 12 | Drum &Perc Room | 62 | 70's Style |
| 13 | Share/Tom Live/Plate | 63 | Room- Large Hall |
| 14 | Big Snare/ Real Room | 64 | Delay Phased |
| 15 | Toms & a Big Share | 65 | Chorused Ambience |
| 16 | Toms & a Short snare | 66 | Predelayed Hall |
| 17 | Drum Amb+Short Snare | 67 | Chorused Warm Hall |
| 18 | Perc Plate +S Room | 68 | Compresed Share Verb |
| 19 | Short Plate + L Room | 69 | Chorused Spring Verb |
| 20 | Ambience & Liveverb | 70 | Gated Live Reverb |
| 21 | Tap Delay/Small Hall | 71 | Delays and Hall |
| 22 | Small/Large Halls | 72 | Five seconds Later |
| 23 | Gold Plate/Warm Hall | 73 | Wurlitzer Verb+Delay |
| 24 | Plate & Spring | 74 | Spread out Verb |
| 25 | Bright Hall & Room | 75 | Acoustic GTR |
| 26 | Wide/ Narrow Room | 76 | BG's Spread |
| 27 | Medium/Small Room | 77 | GTR Spring & Delay |
| 28 | Large /Medium Room | 78 | GTR Spring & Chorus |
| 29 | Large/Small Chamber | 79 | GTR Spread |
| 30 | Slap Dly + Med Room | 80 | Rhodes Verb & Chorus |
| 31 | Detune and Med Room | 81 | Dual Compressor |
| 32 | Generic1 Hall/Spring | 82 | Dual Gate/ Expander |
| 33 | Generic2 Amb/Live | 83 | Phaser + Termolo |
| 34 | Live Hall +Slapbak | 84 | Dual EQ |
| 35 | Saxophone Room | 85 | Dual Delays |
| 36 | Horns Hit Me | 86 | Delay and Chorus |
| 37 | Horns Med/Large Room | 87 | Flanger & Chorus |
| 38 | Synth Hall+Ambience | 88 | Tremolo & Compressor |
| 39 | Repeats & Slapback | 89 | Slap Dly+Spring Verb |
| 40 | The Pack 1SN 2VOX | 90 | Phaser & Spring Verb |
| 41 | Delay bleed-Hall | 91 | Stereo Compressor |
| 42 | Detune bleed- Ambient | 92 | Stereo Limiter |
| 43 | M-one Magic | 93 | Stereo Gate / Expander |
| 44 | Tape Delay - Spring | 94 | Stereo EQ-Loudness |
| 45 | Phaser - Plate | 95 | Stereo EQ -Low Boost |
| 46 | Delay bleed-Room | 96 | Stereo EQ HighBoost |
| 47 | Hall bleed - Chorus | 97 | Stereo Phaser |
| 48 | Hall bleed -Hall | 98 | Stereo Real Hall |
| 49 | Room bleed -Hall | 99 | Stereo Real Room |
| 50 | Small Hall - Hall | 100 | Stereo Hall |